

 Roland

MT-32

MULTI TIMBRE SOUND MODULE

Owner's Manual



Bescheinigung des Herstellers /Importeurs

Hiermit wird bescheinigt, daß der/die/das

ROLAND MULTI - TIMBRE SOUND MODULE MT-32

(Gerat, Typ, Bezeichnung)

in Übereinstimmung mit den Bestimmungen der

Amtsbl. Vfg 1046 / 1984

(Amtsblattverfügung)

funk-entstört ist.

Der Deutschen Bundespost wurde das Inverkehrbringen dieses Gerätes angezeigt und die Berechtigung zur Überprüfung der Serie auf Einhaltung der Bestimmungen eingeräumt.

Roland Corporation Osaka / Japan

Name des Herstellers/Importeurs

RADIO AND TELEVISION INTERFERENCE

Warning - This equipment has been verified to comply with the limits for a Class B computing device, pursuant to Subpart J, of Part 15, of FCC rules. Operation with non-certified or non-verified equipment is likely to result in interference to radio and TV reception.

The equipment described in this manual generates and uses radio-frequency energy. If it is not installed and used properly, that is, in strict accordance with our instructions, it may cause interference with radio and television reception.

This equipment has been tested and found to comply with the limits for a Class B computing device in accordance with the specifications in Subpart J, of Part 15, of FCC Rules. These rules are designed to provide reasonable protection against such interference in a residential installation. However, there is no guarantee that the interference will not occur in a particular installation. If this equipment does cause interference to radio or television reception, which can be determined by turning the equipment on and off, the user is encouraged to try to correct the interference by the following measure:

- Disconnect other devices and their input/output cables one at a time. If the interference stops, it is caused by either the other device or its I/O cable.
- These devices usually require Roland designated shielded I/O cables. For Roland devices, you can obtain the proper shielded cable from your dealer. For non-Roland devices, contact the manufacturer or dealer for assistance.
- If your equipment does cause interference to radio or television reception, you can try to correct the interference by using one or more of the following measures:
 - Turn the TV or radio antenna until the interferences stops.
 - Move the equipment to one side or the other of the TV or radio.
 - Move the equipment farther away from the TV or radio.
 - Plug the equipment into an outlet that is on a different circuit than the TV or radio. (That is, make certain the equipment and the radio or television set are on circuits controlled by different circuit breakers or fuses.)
 - Consider installing a rooftop television antenna with coaxial cable lead-in between the antenna and TV.

If necessary, you should consult your dealer or an experienced radio/television technician for additional suggestions. You may find helpful the following booklet prepared by the Federal Communications Commission:

"How to Identify and Resolve Radio-TV Interference Problems"

This booklet is available from the U.S. Government Printing Office, Washington, D.C., 20402, Stock No. 004-000-00345-4.

Please read the separate volume "MIDI", before reading this owner's manual.

Copyright © 1987 by ROLAND CORPORATION

All rights reserved. No part of this publication may be reproduced in any form without the written permission of ROLAND CORPORATION.

CONTENTS

Thank you for purchasing the Roland MT-32 Multi-Timbre Sound Module.

The MT-32 fully conforms to Musical Instrument Digital Interface (MIDI) standards, which define data exchange between electronic musical instruments and devices.

The MT-32 operates in conjunction with the Roland Piano, piano recorder, digital sequencer, and other MIDI-compatible sound sources.

Study this Owner's Manual and keep it handy so that the MT-32 can provide you with many years of musical enjoyment.

CONTENTS

PANEL DESCRIPTION	2
CARE AND MAINTENANCE	4
Power Supply	4
Connection	4
Power-on Procedure	4
Installation	5
Cleaning	5
Cautions	5
1. FEATURES AND USE	6
2. USING THE MT-32 WITH ROLAND SOFTWARE	8
3. USING THE MT-32 WITH ORIGINAL DATA	10
MAJOR SPECIFICATIONS	27

PANEL DESCRIPTION

1. Front Panel

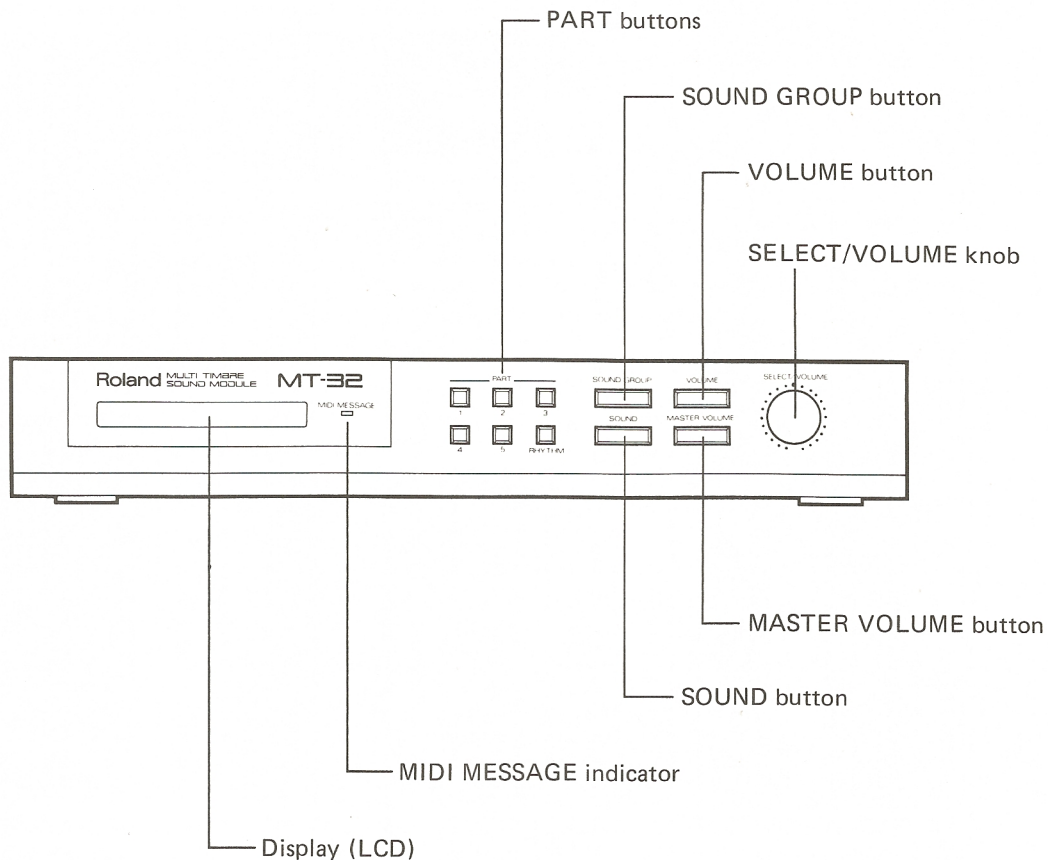

2. Rear Panel

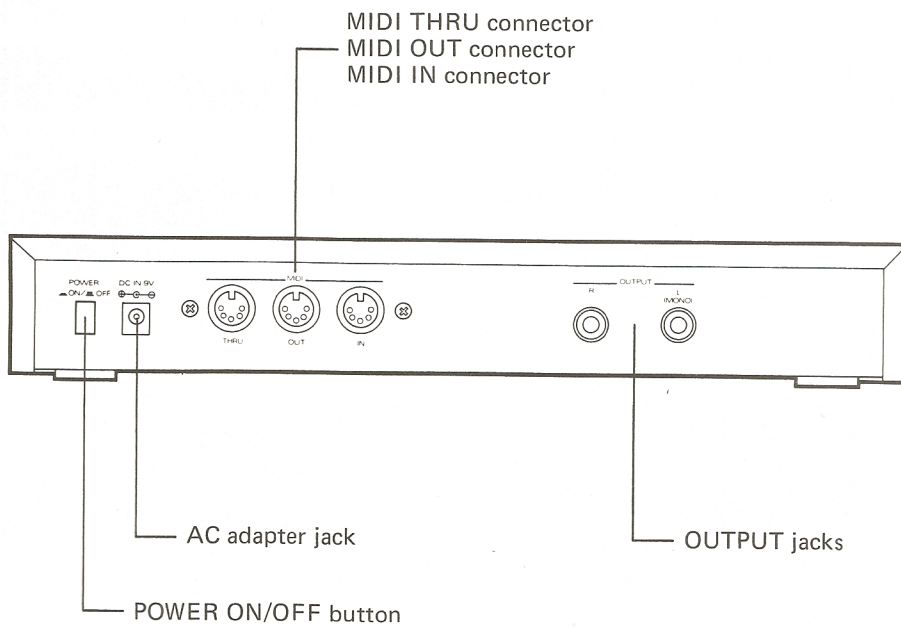

CARE AND MAINTENANCE

POWER SUPPLY

- Be sure to use the AC adapter that comes with the MT-32. Use of a non-standard adapter could lead to errors and breakdowns.
- For use in a region where voltage requirements are different, consult with your nearest Roland sales representative about the ACB-100, ACB-120, ACB-220, or ACB-240 AC adapter.
- Do not use the MT-32 on the same power outlet as a motor, dimmer, or any other equipment that generates noise or consumes a large amount of power.
- Connect the AC adapter to the MT-32's DC IN jack before inserting the power plug in the power outlet.
- Make sure that the MT-32 is turned off before connecting the AC adapter to the power outlet.
- When disconnecting the AC adapter from the power outlet, be sure to pull the power plug itself and not the power cord, to avoid damaged and short-circuiting.
- Avoid damaging the power cord.
- If the MT-32 is not being used for a prolonged period, disconnect the AC adapter from the power outlet.

CONNECTION

- Make sure that all switches are off before setting up or changing equipment connections.

POWER-ON PROCEDURE

- The MT-32 may not operate correctly if you turn it on immediately after a shutdown or connect it to a power outlet with the POWER switch on. If this happens, turn the POWER switch off, then turn it back on several seconds later.
- Set amplifier volume to 0 when turning the power on and off. Too high a volume level will result in an overload, which can damage the speakers.

INSTALLATION

- To prevent adverse effects, protect your MT-32 from:
 - Direct sunlight
 - Temperature and humidity extremes (heaters, etc.)
 - Dust
 - Vibration
- Do not place the MT-32 near a neon tube, fluorescent lamp, television set, cathode-ray tube, or other such equipment that could cause noise interference or errors.

CLEANING

- For daily care, wipe the casing with a dry, soft cloth.
- If the casing is stained, use a cloth slightly dampened with water.
- To remove stubborn stains, clean the casing with a cloth coated with a neutral detergent, then wipe it dry with a soft cloth.
- Never use paint thinners, benzine, or other organic solvents which could damage the casing.

CAUTIONS

- Adjust volume control to a level that will not disturb the neighborhood, especially at night when sounds can travel over a long distance.
- Do not allow fluid or foreign matter, such as water, beverages, coins, and wires, to enter the MT-32.
- Do not examine or modify the internal components or circuitry. Electrical shocks or damage may result.
- Do not subject the MT-32 to a severe impact, nor move it while the power is on.
- If the MT-32 fails to operate correctly, turn off immediately and contact your nearest Roland service representative.

HOW TO USE MT-32 FEATURES

1. FEATURES AND USE

The MT-32 multi-timbre sound module contains a sound source capable of supplying eight independent parts and thirty rhythm sounds.

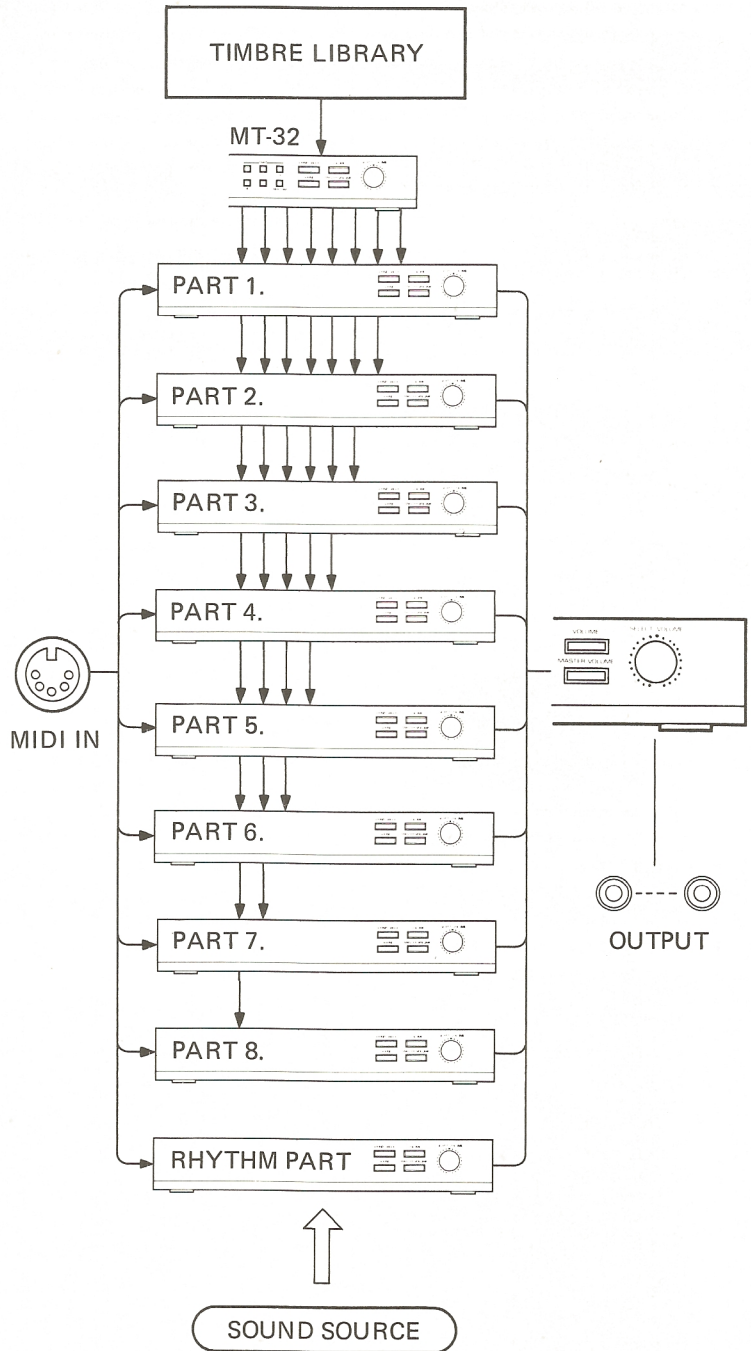

The MT-32 incorporates a 128-timbre sound library that lets you select sounds for any of the non-rhythm parts.

The sound source block allows you to play up to thirty-two notes for the eight parts simultaneously, each of which may consist of any number of notes within the upper limit. (The exact voicing capacity allowed, however, varies with the timbres you select. See page 22 for details.)

The MT-32 works in conjunction with a MIDI keyboard, sequencer (a device that stores musical data for playback at the desired timing), and other instruments that generate MIDI data.

The MT-32 applications are roughly broken down into the following two categories. See the corresponding section for a full explanation.

- (1) Using the MT-32 with the Roland Piano, the Roland PR-100 Digital Sequencer, and Roland PR-100 Pre-Recorded Software
→ See Section [2] "USING THE MT-32 WITH ROLAND PR-100 PRE-RECORDED SOFTWARE" (page 8).
- (2) Using the MT-32 with a sequencer loaded with your own data
→ See Section [3] "USING THE MT-32 WITH ORIGINAL DATA" (page 10).

2. USING THE MT-32 WITH ROLAND PR-100 PRE-RECORDED SOFTWARE

When using the MT-32 with the Roland Piano, Roland PR-100 Digital Sequencer, and Roland PR-100 Software, connect the instruments as shown below:

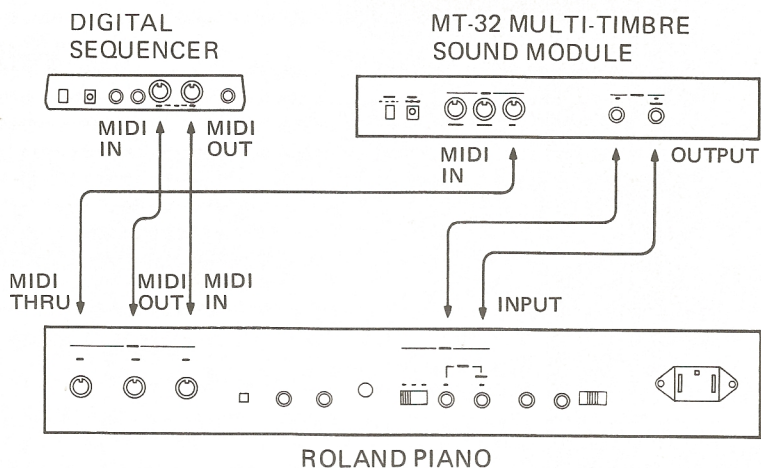

When connections are complete, turn on the piano, MT-32, then the PR-100. Follow the instructions given in the PR-100 and software manuals.

*Set SOFT THRU ON on the sequencer, and set LOCAL OFF (→ "—" position) on the Roland Piano.

*To send MT-32 output to the built-in speaker of the Roland Piano, set the Roland Piano input level switch to the high position.

The following two steps are all that is required to set up the MT-32:

● MASTER VOLUME

Set the overall volume level of the MT-32.

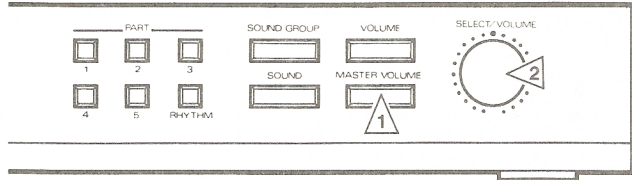

(1) Press the MASTER VOLUME button, (2) then adjust with the SELECT/VOLUME control.

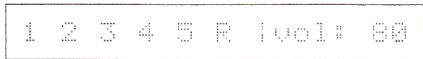

*If the reading on the display remains unchanged when the SELECT/VOLUME knob is turned, turn the knob counterclockwise until the volume number in the display begins to change, then readjust.
(To prevent any sudden change in output level, the SELECT/VOLUME control must be turned to the position of output level as shown in the display before any adjustment can be made.)

● REVERB MODE

Select the reverb mode as necessary for the master output from the MT-32.

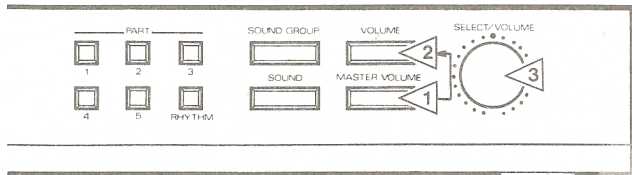

(1) While holding down the MASTER VOLUME button and (2) press the VOLUME button, then (3) turn the SELECT/VOLUME control to adjust the reverb depth mode.

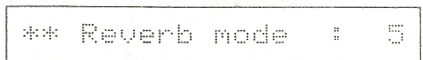

*The reverb mode will not effect any part which the Reverb has been disabled by software.

More functions are available to the user, but they may not provide noticeable effects if the MT-32 is controlled by software. The software overrides user-defined settings when there is a parameter conflict.

3. USING THE MT-32 WITH ORIGINAL DATA

Working knowledge of MIDI implementation is necessary if you intend to compile your own sequencer data to play on the MT-32. Study the separate volume "What Is MIDI" before starting.

Connect the equipment as shown below:

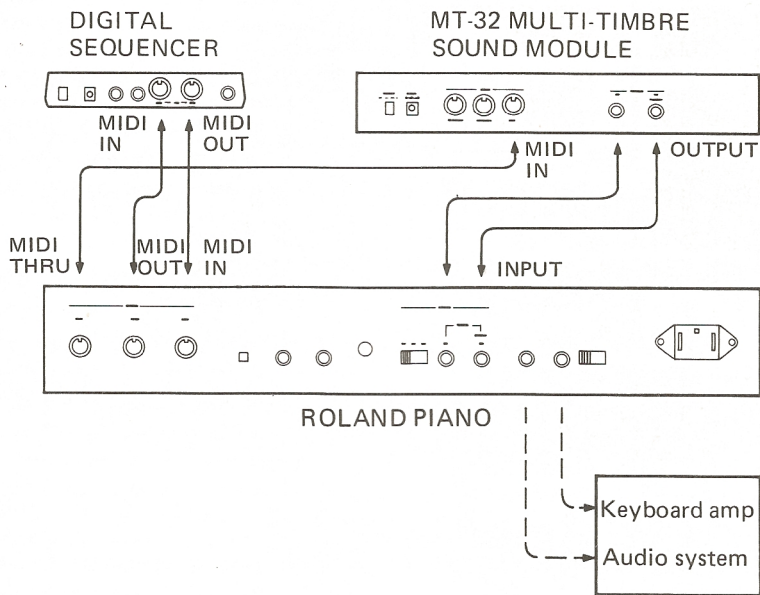

*If the keyboard does not have a MIDI THRU port, use the following connection:

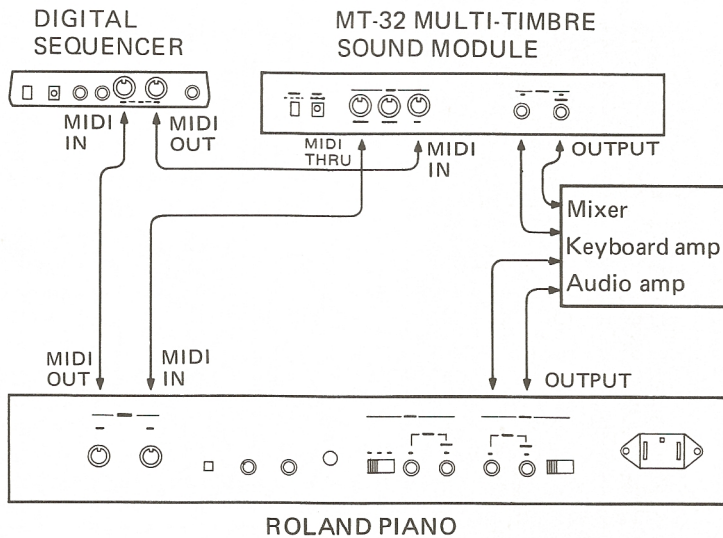

* Always turn on the piano, MT-32 before turning on the sequencer.

Not all of the MT-32 features are available unless the sequencer used is capable of generating data that allows access to such functions. Essential requirements are that either (1) the keyboard for compiling data or (2) the sequencer alone allows you to produce data compatible with the MT-32.

In short, the exact functions that the MT-32 provides vary with the performance of the sequencer and the keyboard you are going to use.

The sections that follow explain how the MT-32 responds to data from a MIDI source. For the data specifications and data exchange procedures, refer to the manuals for the sequencer and keyboard.

*Set SOFT THRU ON on the sequencer, and set LOCAL OFF (→"':" position) on the Roland Piano.

	Page
1. Built-in Functions	12
2. User-accessible Functions	15
3. Functions Accessible with an External MIDI Message . .	20
a. Program Change and Control Change	20
b. MIDI System Exclusive Messages	21
(1) Overall Control for the MT-32 Functions	22
(2) Control over Parts 1 to 8	23
(3) Writing User Patches to Memory	24
(4) Timbre Control	25
(5) Writing Timbre Data to Memory	26
(6) Rhythm Part Control	26
(7) Data Transfer	26

1. BUILT-IN FUNCTIONS

This section explains the MT-32's built-in functions.

● MIDI CHANNELS

The following is the default channel configuration for the nine parts. The MT-32 checks the channels used to compile data when determining the parts it will play.

Part	1	2	3	4	5	6	7	8	Rhythm
Channel	2	3	4	5	6	7	8	9	10

The channel configuration can be switched to the following:

Part	1	2	3	4	5	6	7	8	Rhythm
Channel	1	2	3	4	5	6	7	8	10

PROCEDURE

Press PART button 5 while holding down the MASTER VOLUME button, then press PART button 1.

*The rhythm setting (Channel 10) remains unchanged.

Following is a list of Rhythm instrument voices contained in the MT-32 with the note number assigned to each voice.

	(76)
(75) Claves	(74)
(73) Quijada	(72) Smba Whis L
	(71) Smba Whis S
(70) Maracas	(69) Cabasa
(68) Low Agogo	(67) High Agogo
(66) Low Timbale	(65) High Timbale
	(64) Low Conga
(63) High Conga	(62) Mt High Conga
(61) Low Bongo	(60) High Bongo
	(59)
(58)	(57)
(56) Cowbell	(55)
(54) Tambourine	(53)
	(52)
(51) Ride Cym	(50) Acou Hi Tom
(49) Crash Cym	(48) Acou Hi Tom
	(47) Acou Mid Tom
(46) Open Hi Hat 1	(45) Acou Mid Tom
(44) Open Hi Hat 2	(43) Acou Low Tom
(42) Clsd Hi Hat	(41) Acou Low Tom
	(40) Elec SD
(39) Hand Clap	(38) Acou SD
(37) Rim Shot	(36) Acou BD
	(35) Acou BD

The numbers in () are the Key numbers.

● STEREO BALANCE IN THE PHYTHM PART

(Stereo balance)

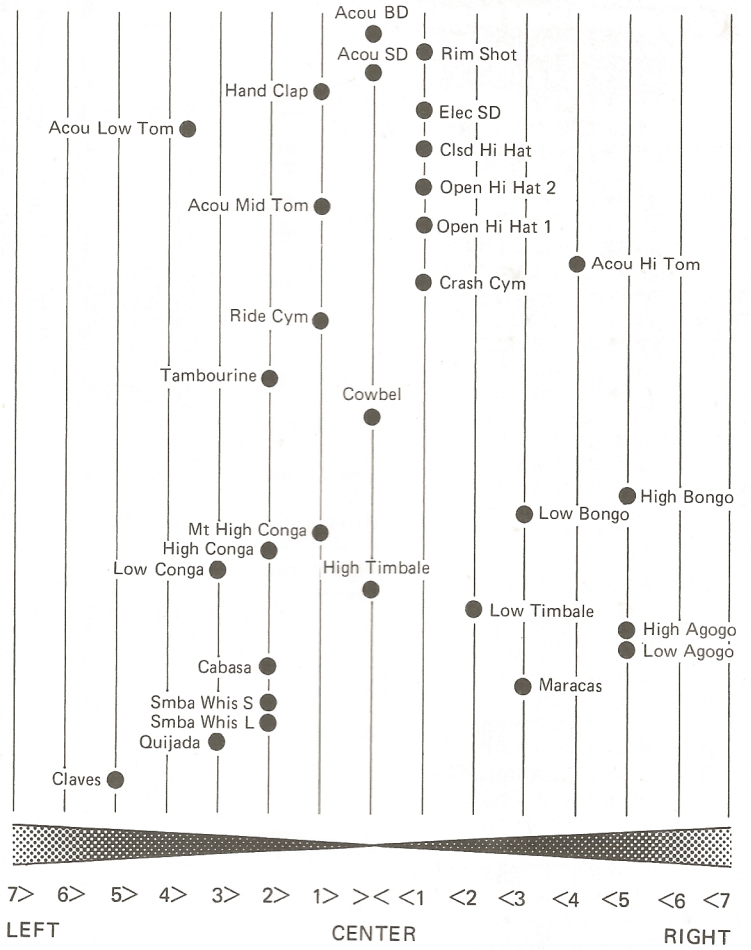

2. USER-ACCESSIBLE FUNCTIONS

This section explains the functions that are accessible to the player using the MT-32's control panel.

OVERALL FUNCTIONS

● MASTER VOLUME

This function determines the overall output level from the MT-32.

PROCEDURE

Press the **MASTER VOLUME** button, then adjust with the **SELECT/VOLUME** control.

Adjustable range: 0 (min volume) to 100 (max volume)

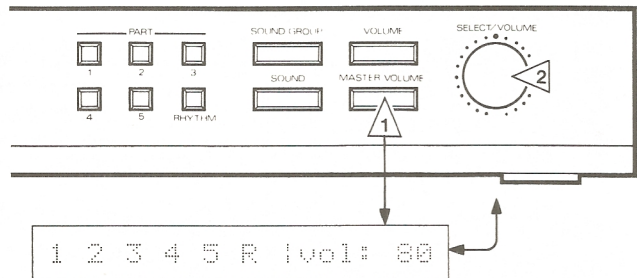

The part currently played continues flashing.

* If the reading on the display remains unchanged when the **SELECT/VOLUME** control is turned, turn the control counter-clockwise until the volume number in the display begins to change, then readjust.

(To prevent any sudden change in output level, the **SELECT/VOLUME** control must be turned to the position of output level as shown in the display before any adjustment can be made.)

● UNIT NUMBER

This function changes the unit number, which identifies the MT-32 receiving a System Exclusive message. The unit number should not be changed in regular MT-32 applications.

PROCEDURE

Press the **SOUND** button while holding down the **MASTER VOLUME** button, then turn the **SELECT/VOLUME** control to change the unit number.

Adjustable range: 1 to 32

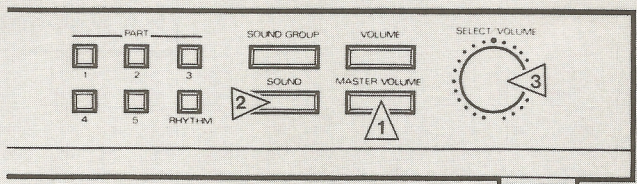

● MASTER TUNING

This function adjusts the pitch of the overall output from the MT-32. It is used to tune the MT-32 to the other instruments.

PROCEDURE

Press the SOUND GROUP button while holding down the MASTER VOLUME button, then turn the SELECT/VOLUME control to adjust the master tuning.

Adjustable range:

427.5 to 452.6 Hz (Standard pitch: A = 442 Hz)

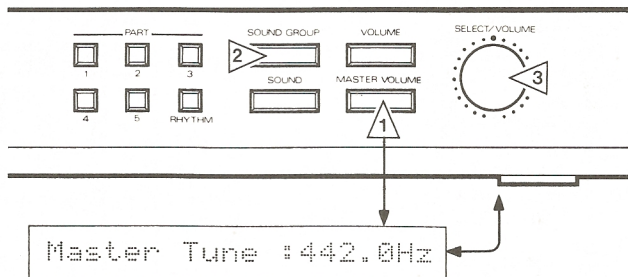

● REVERB MODE

Select the reverb mode as necessary for the overall output from the MT-32.

PROCEDURE

Press the SOUND GROUP button while holding down the MASTER VOLUME button, then turn the SELECT/VOLUME control to adjust the reverb mode.

Adjustable range: 0 – 10

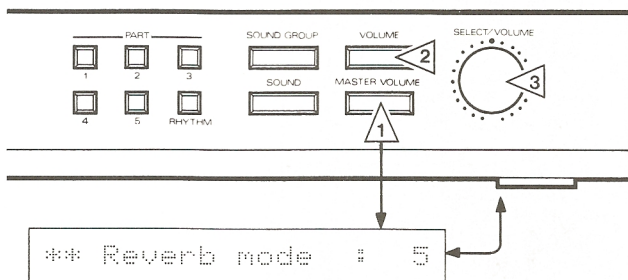

● OVERFLOW ASSIGN

This function allows the MT-32 to generate MIDI notes beyond its capacity and send the excess out of the MIDI OUT port to the input of an additional external MIDI instrument.

PROCEDURE

Press PART button 4 while holding down the MASTER VOLUME button, then press PART button 1.

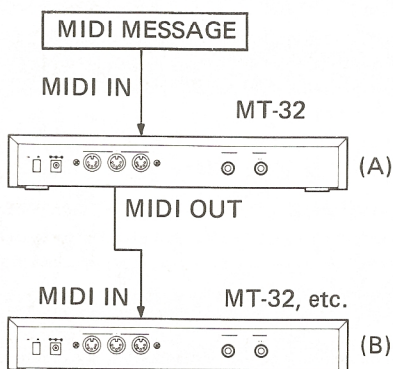

Module (A) sends excess data from its MIDI OUT port to module (B) for remote output.

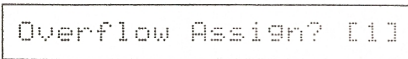
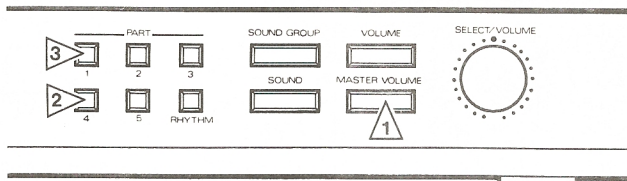

* This function remains in effect until you turn off the MT-32.

● ALL RESET

This function resets all the current settings and initialized the MT-32 to the power-on defaults. It is useful when a sound remains on after you have stopped playing MIDI data part way through.

PROCEDURE

Press PART button RHYTHM while holding down the MASTER VOLUME button, then press PART button 1.

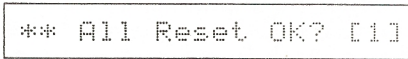
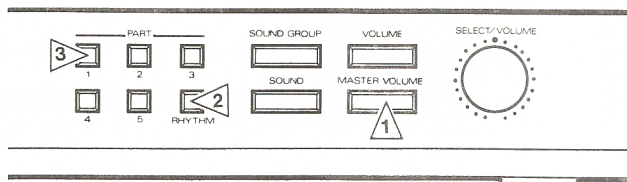

* If you press one of PART buttons between 2 and 5 instead of PART button 1, the MT-32 will reset all settings except for the patch memory and rhythm setup functions.

● TIMBRE SETUP

The MT-32 comes with an internal 128-timbre data library that lets you select sounds for any of the non-rhythm parts.

→ Refer to the separate volume "Sound List" for a full description of the timbres.

The 128 timbres are classified into separate sound groups, each containing from four to eleven timbres.

PROCEDURE

- (1) Press the PART button that corresponds to the part for which you wish to select the timbre. (You can select parts 6, 7, 8, by pressing part switches 1, 2, 3 while pressing MASTER VOLUME switch.)

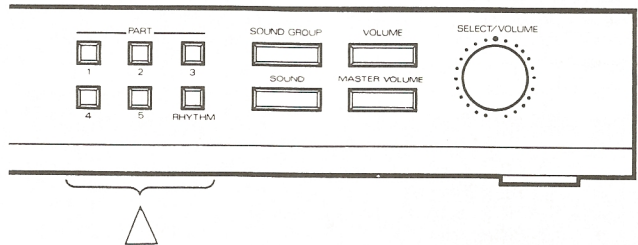

- (2) Press the SOUND GROUP button, then select the sound group you desire with the SELECT/VOLUME control.

1>Piano |AcouPiano1

FLASHING

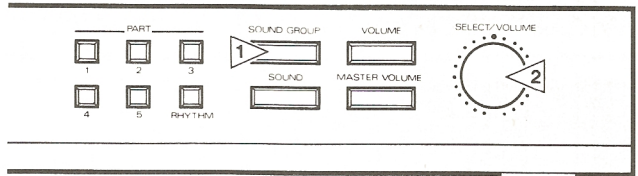

1|Piano >AcouPiano1

FLASHING



1|Piano >*****

NAME OF TIMBRE

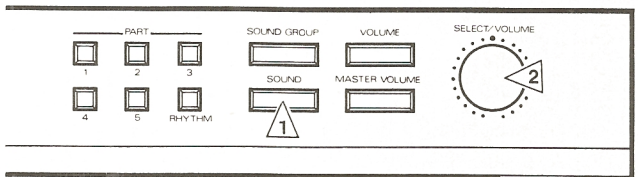

● VOLUME FOR EACH PART

This function allows independent volume control for each part, including the rhythm part.

PROCEDURE

- (1) Press the PART button that corresponds to the part for which you wish to adjust the volume.

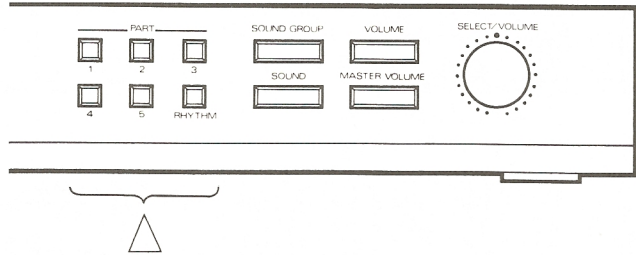
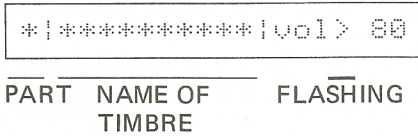

- (2) Press the VOLUME button, then set the volume with the SELECT/VOLUME control. Adjustable range: 0 – 100

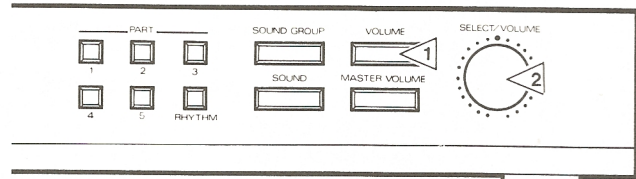
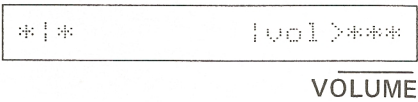

* If the reading on the display remains unchanged when the SELECT/VOLUME control is turned, turn the knob counter-clockwise until the volume number in the display begins to change, then readjust.

(To prevent any sudden change in output level, the SELECT/VOLUME control must be turned to the position of output level as shown in the display before any adjustment can be made.)

3. FUNCTIONS ACCESSIBLE WITH AN EXTERNAL MIDI MESSAGE

a. Program Change and Control Change

The MT-32 accepts external MIDI messages (Program Change and Control Change) which redefine the MT-32 settings. These messages provide independent control over any of the non-rhythm parts.

● TIMBRE SETUP (PROGRAM CHANGE)

This function allows the MT-32 to select the timbre as specified by an external Program Change number (a superscript appearing to the left of the timbres in the "Sound List").

*The timbre setup procedure using a Program Change number differs from the one using the MT-32 control panel. See page 23 for details.

● MODULATION DEPTH (CONTROL CHANGE [1])

This function changes the vibrato effect.

● VOLUME LEVEL FOR EACH PART (CONTROL CHANGE [7])

This function sets the volume level for each part.

● PAN-POT (CONTROL CHANGE [10])

This function changes the stereo balance of the MT-32 output.

● EXPRESSION (CONTROL CHANGE [11])

This function controls sound dynamics.

*The sound dynamics can be controlled by the Expression and the volume level settings (as determined by the MT-32 control panel setting or Control Changes [7] and [11]).

● HOLD (CONTROL CHANGE [64])

This function causes the MT-32 to suspend control so that continuous notes maintain the sustain level and attenuating notes simulate the effect of a piano damper pedal.

b. MIDI System Exclusive Messages

The MT-32 accepts MIDI System Exclusive messages from an external controller (Keyboard, Computer, Sequencer etc.)

Because the data format for MIDI System Exclusive messages varies from one manufacturer to another, this data format must comply with the specifications designated by Roland when sent to the MT-32.

The MT-32 therefore does not accept System Exclusive messages unless the sequencer — whether it is manufactured by Roland or not — allows the user to compile messages from keypad, as with the Roland MC-500.

For details on the MIDI System Exclusive message and data input procedures, refer to MIDI implementation reference.

* For functions that allow access from the MT-32's control panel as well as Program Change and Control Change messages, the MT-32 retains the settings specified by the data last received.

1) OVERALL CONTROL FOR THE MT-32 FUNCTIONS

FUNCTION	DESCRIPTION	ADJUSTABLE RANGE
Master tuning	Changes the overall pitch of the MT-32.	432.1 to 457.6 Hz
Reverb mode	Selects the reverb type.	Room, Hall, Plate and Tap-delay
Reverb time	Sets the reverb duration.	1 to 8
Reverb level	Sets the reverb intensity.	0 to 7
Partial reserve (Parts 1 to 8 and rhythm)	(See below.)	0 to 32
MIDI channel (Parts 1 to 8 and rhythm)	Selects a MIDI channel for each part.	OFF or 1 to 16
Master volume	Sets the overall volume level for the MT-32.	0 to 100

○PARTIAL

The smallest unit that defines a timbre is called a "partial". While a single partial is enough to produce a simple tone, multiple partials are required to generate complex sounds.

Because the MT-32 is capable of generating up to thirty-two notes at a time, it requires exactly thirty-two partials to use its maximum capacity. The maximum capacity for generating notes simultaneously, therefore, reduces as the number of notes consisting of multiple partials increases.

○PARTIAL RESERVE

Partial Reserve is a function that allows the MT-32 to selectively define the number of partials that each part can use.

If a note requires partials beyond the upper limit of a part, the MT-32 will check the other parts for unused partials and allocate them, if available, to that part. If a part runs short of partials due to the Partial Reserve function, the MT-32 will terminate the part and send the partials back to the original part.

The Partial Reserve function thus ensures that every part has at least the number of partials assigned to it.

2) CONTROL OVER PARTS 1 TO 8

The Figure below shows musical data stored in memory together with the corresponding timbre data. A group of such data is called a "patch". A patch comes in 128 variations on the MT-32.

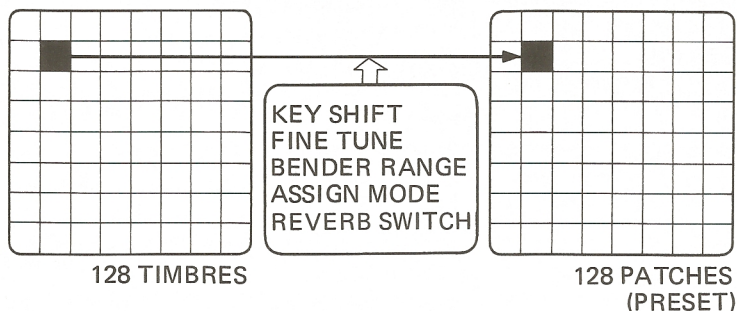

Unlike the "Timbre Setup" function (see page 18) that merely switches between different timbres, an externally supplied Program Change message causes the MT-32 to switch to the new patch and use the settings stored in that specified patch memory.

FUNCTION	DESCRIPTION	ADJUSTABLE RANGE
Sound group	Selects the sound group of timbres.	A, B, M, or R (1-30)
Sound number	Selects the timbre number.	1 to 64
Key shift	Indicates the actual shift relative to the note data.	-24 to +24 in semitones
Fine tune	Allows fine tuning.	-50 to 50 cents
Bender range	Sets the maximum effect of the Bender.	0 to 24
Assign mode	(See below.)	POLY 1, 2, 3, or 4
Reverb switch	Turns the reverb effect on and off.	ON or OFF

System Exclusive messages allow the user to freely edit the settings in such patch memories.

○ ASSIGN MODE

The assign mode determines how the MT-32 generates sounds in response to the note-on data it will receive:

- POLY 1: Polyphonic mode, single assign, priority given to data last received.
- POLY 2: Polyphonic mode, single assign, priority given to data first received.
- POLY 3: Polyphonic mode, multiple assign, priority given to data last received.
- POLY 4: Polyphonic mode, multiple assign, priority given to data first received.

SINGLE ASSIGN

This function causes the MT-32 to stop playing a note, then restart on the same note when it receives note-on data that has the same note number as the current one.

MULTIPLE ASSIGN

This function causes the MT-32 to switch to another voice and continue playing a note when it receives note-on data that has the same note number as the current one.

PRIORITY TO LAST DATA [First in, First out]

If the new note-on messages exceed the number of notes played simultaneously, the MT-32 will stop playing notes one after another in the order in which it started playing them.

PRIORITY TO FIRST DATA [First in, Last out]

If the new note-on messages exceed the number of notes played simultaneously, the MT-32 will stop playing notes one after another in the order opposite to that in which it started playing them.

3) WRITING USER PATCHES TO MEMORY

The MT-32 allows a System Exclusive patch to replace any of the 128 built-in patches.

4) TIMBRE CONTROL

This function allows the user to compile and edit timbre data.

COMMON PARAMETER	ADJUSTABLE RANGE
Name	Alphanumerics and symbols
Structure 1, 2 (3, 4)	1 to 13
Partial Mute	OFF, ON
ENV Mode	Normal, NO Sustain

PARTIAL PARAMETER		ADJUSTABLE RANGE
WG Pitch	Coarse	C1, C#1 ... C9
	Fine	-50 ... 0 ... +50
	Keyfollow	-1, -1/2, -1/4, 0, 1/8, 1/4, 3/8, 1/2, 5/8, 3/4, 7/8, 1, 5/4, 3/2, 2 s1, s2
	Bender Switch	Off/On
WG	Waveform	Square/Sawtooth
	PCM Wave No.	1 ... 128
	Pulse Width	0 ... 100
	PW Velocity Sense	-7 ... 0 ... +7
P-ENV	Depth	0 ... 10
	Velocity Sens	0 ... 100
	Time Keyfollow	0 ... 4
	Time 1/2/3/4	0 ... 100
	Level 0/1/2	-50 ... 0 ... +50
	Sustain level	-50 ... 0 ... +50
	End level	-50 ... 0 ... +50
P-LFO	Rate	0 ... 100
	Depth	0 ... 100
	Modulation Sense	0 ... 100
TVF	Cutoff Frequency	0 ... 100
	Resonance	0 ... 30
	Keyfollow	-1, -1/2, -1/4, 0, 1/8, 1/4, 3/8, 1/2, 5/8, 3/4, 7/8, 1, 5/4, 3/2, 2
	Bias Point/Direction	<A1...<C7, >A1...>C7
	Bias Level	-7 ... 0 ... +7
TVF ENV	Depth	0 ... 100
	Velocity Sense	0 ... 100
	Depth Keyfollow	0 ... 4
	Time keyfollow	0 ... 4
	Time 1/2/3/4/5	0 ... 100
	Level 1/2/3	0 ... 100
	Sustain Level	0 ... 100
TVA	Level	0 ... 100
	Velocity Sense	-50 ... 0 ... +50
	Bias Point 1/2	<A1...<C7, >A1...>C7
	Bias level 1/2	-12 ... 0
TVA ENV	Time Keyfollow	0 ... 4
	Time 1 Velocity Follow	0 ... 4
	Time 1/2/3/4/5	0 ... 100
	Level 1/2/3	0 ... 100
	Sustain Level	0 ... 100

5) WRITING TIMBRE DATA TO MEMORY

The MT-32 is capable of storing up to 64 different timbres at memory locations that are not used by the built-in timbres.

6) RHYTHM PART CONTROL

Any key number between 24 and 87 is accessible to the user for the following functions:

FUNCTION	DESCRIPTION	ADJUSTABLE RANGE
Timbre	Selects the timbre.	R: 01 to 30 M: 01 to 64
Output level	Adjust the output volume.	0 to 100
Pan-pot	Adjust the stereo balance.	15-steps between L and R
Reverb switch	Turns the reverb effect on and off	ON or OFF

7) DATA TRANSFER

The MT-32 allows bulk dump or load of all memory-resident data.

* The MT-32 does not allow bulk dump (data transfer) unless it receives a request-to-send message from a remote instrument. Therefore, data transfer is not possible between MT-32 units.

MAJOR SPECIFICATIONS

MT-32 Multi-timbre Sound Module

Sound source:

LA [Linear Arithmetic synthesis]

Number of notes:

Up to 32 simultaneously

Number of timbres:

Up to 8 and one Rhythm Part simultaneously

Preset timbres:

128 for Sound Parts and 30 for Rhythm Part

Control panel buttons:

PART buttons 1 through 5 and one RHYTHM button
(Parts 6 to 8 also accessible)

SOUND GROUP button

SOUND button

VOLUME button

MASTER VOLUME button

SELECT/VOLUME control

Display:

20-character backlit liquid crystal display

Connectors:

OUTPUT jacks – L (mono) and R

MIDI connectors – IN, OUT, and THRU

DC IN jack

Power supply:

9V DC (supplied by ACB-Series AC adapter)

Current consumption:

650 mA (at 9V DC)

External dimensions:

305 mm(width) x 220 mm(depth) x 45 mm(height)

12" x 8-1/2" x 1-3/4"

(except for the protruding sections)

Weight:

1.5 kg/3 lb 5 oz

ACCESSORIES (Supplied):

AC adapter (ACB-Series)

MIDI cable (1 pc.)

Connecting cord (2 pcs.)

Owner's Manual

"Sound List"

"What Is MIDI"

* The specifications of this product are subject to change without prior notice for improvement.

Information

- Please use this AC adaptor only with the specified device.
- Please use the AC Adaptor of an appropriate voltage (120, 220 or 240) depending on the voltage system in your country.
- When the device is not to be used for a long period, be sure to disconnect the AC adaptor (Power Supply Unit) from the wall outlet.
- When you need repair service, call your local Roland Service Station as shown below or the authorized Roland distributor in your country.

U.S.A.

Roland Corp US
7200 Dominion Circle
Los Angeles, CA, 90040-3647
U.S.A.
☎ (213) 685-5141

CANADA

Roland Canada Music Ltd.
(Head Office)
13880 Mayfield Place,
Richmond
British Columbia
Canada V6V 2E4
☎ (604) 270-6626

Roland Canada Music Ltd.
3469-rue Ashby
St-Laurent,
Quebec H4R 2C1
☎ (514) 335-2009

Roland Canada Music Ltd.
Unit B12-1515 Matheson Blvd
Mississauga, Ontario L4W 2P5
☎ (416) 625-4880

AUSTRALIA

Roland Corporation
(Australia) Pty. Ltd.
(Head Office)
38 Campbell Avenue
Dee Why West, NSW 2099
Australia
☎ (02) 982-8286

Roland Corporation
(Australia) Pty. Ltd.
(Melbourne Office)
50 Garden Street
South Yarra, Victoria 3141
Australia
☎ (03) 241-1254

NEW ZEALAND

Roland Corporation
(NZ) Ltd.
9 Nugent Street, Grafton
Auckland 3
New Zealand
☎ (09) 398-715

UNITED KINGDOM

Roland (UK) Ltd.
Great West Trading Estate
983 Great West Road
Brentford, TW8 9DN,
Middlesex, England
☎ (01) 568 4578

WEST GERMANY

Roland Elektronische
Musikinstrumente
Handelsgesellschaft mbH.
Oststrasse 96,
2000 Norderstedt
West Germany
☎ 040/526 0090

BELGIUM/HOLLAND LUXEMBOURG

Roland Benelux N.V.
Houtstraat 1
B-2431 Oevel-Westerlo
Belgium
☎ 014-58 45 35

DENMARK

Roland Scandinavia A/S
Norre Sogade 49, 1370
Copenhagen K,
Denmark
☎ (01) 11 31 11

SWEDEN

Roland Scandinavia A/S
Storskarsgatan 4
115 29 Stockholm
Sweden
☎ 08-65 32 40/65 32 50

NORWAY

Benum Music A/S
Haakon den godes Vei 14
N-0319 Oslo 3, Norway
(Box 145 Vinderen, N-0319
Oslo 3 Norway)
☎ 02 141266

FINLAND

OY Musiikki Fazer Musik AB
Takomotie 3
00380 Helsinki 38, Finland
☎ 05 66551

ITALY

Roland Italy S.p.A.
Via Gallarate 58
20151 Milano
Italy
☎ 02-3086849

SWITZERLAND

Musitronic AG
Gerberstrasse 5, CH-4410
Liestal
Switzerland
☎ 061/91 16 15

FRANCE

Musikengro
102, Avenue Jean-Jaures
69007 Lyon Cedex 07
☎ (7) 858 54 60

Musikengro
(Paris Office)
Centre Region Parisienne
41 rue Charles-Fourier, 94400
Vitry s/Seine
☎ (1) 680 86 62

SPAIN

Vietronic S.A.
Bolivia 239
08020 Barcelona
☎ 93-307 47 12

AUSTRIA

E. Dematte & Co.
Nue-Rum Siemens-Strasse 4
A-6021 Innsbruck box 591
☎ (05222) 63 451

GREECE

A. ANDREADES & Co. I.T.D.
2 Phidiou street,
GR 10026B Athens
☎ 3620180

MT-32

'87-12-A4-51

 Roland